

Article number: 46912011

Description: Torque limiter Safeguard A 20 S

## Measures

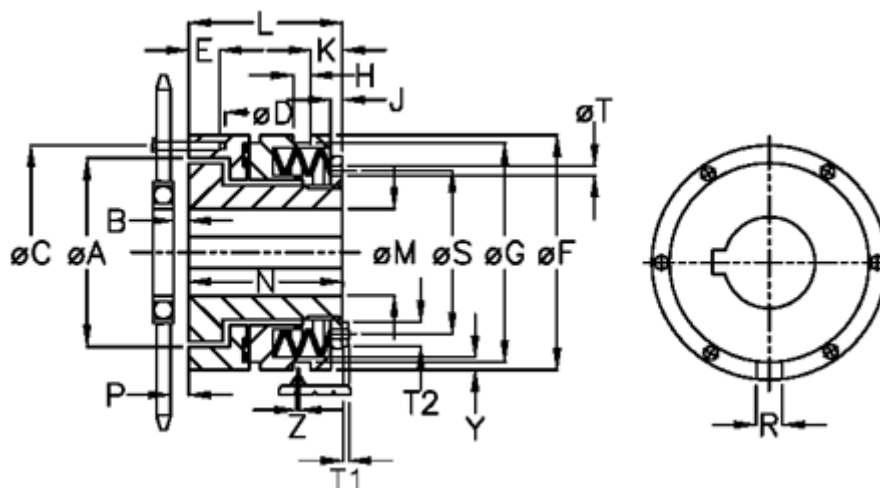

A	= 41.0	G	= 50.0	P	= 3.0
B	= 4.0	H	= 9	R	= 6
C	= 48	J	= 3.0	S	= 36
D	= 6xM5	K	= 8.0	T	= 4
Disc spring mounting	= 6x1S	L	= 39.0	T1	= 3.0
Disc spring version	= S - light	M max	= 20	T2	= 7
E	= 7.0	M min	= 7	Y	= 2
F	= 55	N	= 35.0	Z	= 0.0